

Operating instructions

For responsible bodies and persons using the machine

Pipe Cutting and Beveling Machine

GFX 3.0



Machine no.:

.....
.....

Translation of original
operating instructions
Code 790 144 762 | EN



To work safely with this machine, please read through the operating instructions in full before initial operation.
Retain the operating instructions for future reference.

TABLE OF CONTENTS

1.	About these instructions	4	5.2	Line laser	16
1.1	Warning messages	4	6.	Initial operation	17
1.2	Further symbols and displays	4	6.1	Checking the parts of delivery	17
1.3	Abbreviations	4	6.2	Included with the machine	17
2.	Information and safety instructions for the responsible body	5	7.	Storage and transport	18
2.1	Requirements for the responsible body	5	7.1	Transporting the machine	18
2.2	Using the machine	5	8.	Set-up and assembly	19
2.2.1	Proper use	5	8.1	Fitting the GFX 3.0 onto the workbench	20
2.2.2	Improper use	5	8.1.1	Mounting the machine <u>without</u> quick-mounting plate directly onto the workbench	20
2.2.3	Machine constraints	6	8.1.2	Mounting the machine <u>with</u> quick-mounting plate <u>without</u> screw clamps	20
2.2.4	Shutting down the machine	6	8.1.3	Mounting the machine <u>with</u> quick-mounting plate <u>without</u> screw clamps	20
2.3	Environmental protection/disposal	6	8.2	Saw blade clamping point 1: Fitting the saw blade/bevel cutter	21
2.3.1	Chips and gear lubricant oil	6	8.2.1	Inserting the saw blade	21
2.3.2	Electric tools and accessories	6	8.2.2	Inserting the saw blade/ bevel cutter combination or a bevel cutter	21
2.3.3	Returning batteries	7	8.3	Saw blade clamping point 2: Fitting the saw blade	22
2.4	Basic safety instructions	7	8.3.1	Inserting the saw blade	22
2.5	Warning symbols	10	8.4	Adjusting the pipe dimension	22
3.	Product design	11	8.4.1	Setting the pipe dimension with a scale	23
3.1	Pipe Cutting and Beveling Machine GFX 3.0	11	8.4.2	Setting the pipe dimension without a scale	23
3.2	Accessories	12	8.4.3	Setting the pipe dimension when using an additional cutter	23
3.2.1	Saw blades and bevel cutters	12	9.	Operation	24
3.2.2	Stainless steel clamping attachment	12	9.1	Shutting down (even in an emergency)	25
3.2.3	Quick-mounting plate without screw clamps	12	9.2	Selecting the speed levels	25
3.2.4	Quick-mounting plate with screw clamps	13	9.3	Cutting pipes	25
3.2.5	Durable storage and shipping case	13	9.4	Beveling pipes	26
3.2.6	Saw blade lubricant GF TOP	13	9.5	Cutting and beveling pipe simultaneously ...	26
3.2.7	Saw blade lubricant GF LUB	13	9.6	Cutting pipe elbows	26
3.2.8	Warning symbols	13	10.	Servicing, maintenance, troubleshooting	27
4.	Features and scope of application	14	10.1	Maintenance	27
4.1	Features	14	10.1.1	Laser	27
4.1.1	Motor	14	10.2	Mounting instruction for laser/ Change of batteries	28
4.1.2	Additional saw blade clamping point for cutting pipe elbows only ...	14	10.3	What to do if ...? – General trouble shooting	28
4.1.3	Line laser to determine cut-off point	14	10.4	Servicing/customer service	28
4.1.4	Plug connection with quick-disconnect coupler	14	11.	EG Declaration of Conformity	29
4.1.5	Tempered steel clamping jaws	15			
4.1.6	Other outstanding features	15			
4.2	Scope of application	15			
4.2.1	Application range	15			
5.	Technical specifications	16			
5.1	Pipe Cutting and Beveling Machine GFX 3.0	16			

1. ABOUT THESE INSTRUCTIONS

To allow quick understanding of these instructions and safe handling of the machine, all the warning messages, notes and symbols used in these instructions are presented here along with their meaning.

1.1 Warning messages

In these instructions, warning messages are used to warn you against the dangers of injury or material damage. Always read and observe these warning messages!



This is a warning symbol. It should warn you against dangers of injury. Follow all instructions which are identified with this safety symbol in order to avoid injuries or death.

Warning symbol Meaning



DANGER

Direct danger!
Non-observance could result in death or critical injury.
⊖ Restrictions (if applicable).
▶ Measures to prevent danger.



WARNING

Possible danger!
Non-observance could result in serious injury.
⊖ Restrictions (if applicable).
▶ Measures to prevent danger.



ATTENTION

Dangerous situation!
▶ Non-observance could result in minor injuries.

ATTENTION

Dangerous situation!
▶ Non-observance could result in material damage.

1.2 Further symbols and displays

Symbol

Meaning

IMPORTANT
NOTE

Notes: Contain particularly important information for comprehension.



Instruction: You must take notice of this symbol.

1.

Request for action in a sequence of actions: You have to do something here.



Single request for action: You have to do something here.



Conditional request for action: You have to do something here if the specified condition is met.

1.3 Abbreviations

Abbr.

Meaning

GFX 3.0

Pipe Cutting and Beveling Machine, type GFX 3.0

2. INFORMATION AND SAFETY INSTRUCTIONS FOR THE RESPONSIBLE BODY

2.1 Requirements for the responsible body

Workshop/outdoor/field application: The responsible body is responsible for safety in the danger zone around the machine, and should allow only qualified personnel to enter the zone or operate the machine in the danger zone.

Employee safety: The safety regulations described in chap. 2 must be observed and work must be carried out with safety in mind using the prescribed protective equipment.

2.2 Using the machine

2.2.1 Proper use

- The machine is to be used solely for processing (cutting and beveling) materials, as specified in chap. 4.2, p. 15 with an outer tube diameter of a max. 78 mm (3 inch).
- The machine casing (vice) can be fixed directly onto the work bench using screws or by means of a mounting plate (Accessories, see chap. 3.2, p. 12). The mounting plate is also screwed to the work bench.
- The machines must only be operated using the voltage levels specified on the drive identification plate and in the "technical data" (see chap. 5, p. 16).
- Only to be used as a drive for motor GF10 (Code 790 144 382 and 790 144 383). The drive motor may only be used in connection with the machine.
- The machine may only be used on tubes and containers that are empty, unpressurized, do not have explosive atmospheres and are not contaminated.



Proper use also includes the following:

- observing all safety instructions and warning messages included in these operating instructions
- carrying out all inspection and maintenance work
- sole use in the original condition with original accessories, spare parts and materials
- processing only materials set out in the operating instructions

2.2.2 Improper use

- A use other than that defined under "proper use" or a use that goes beyond this or the specified constraints shall be considered improper use due to the potential risks involved.
- The responsible body shall be solely responsible for damages that arise through improper use and the manufacturer shall assume no liability whatsoever.
- The removal of safety equipment is not permitted.
- Do not misuse the machine.
- The machine is not intended for use by private consumers.
- The technical values defined for normal operation must not be exceeded.
- Do not use the machine as a drive for applications other than those listed under proper use (chap. 2.2.1).



2.2.3 Machine constraints

- Keep your working area clean. Disorder or unlit working areas can lead to accidents.
- The workplace can be in tube preparation, in plant construction or in the plant itself.
- A radial space requirement/freedom of movement of approx. 1 m around the machine is required for people.
- Work lighting: min. 300 lux.
- Operated by one person.
- Climate conditions: temperature range for machine operation: -15 °C to 40 °C ($< 80\%$ rel. humidity).
- Do not use outdoors in fog, rain or during a thunderstorm.

2.2.4 Shutting down the machin

Information on the EMERGENCY STOP or the shutting down function, see chap. 9.1, p. 25.

2.3 Environmental protection/disposal

2.3.1 Chips and gear lubricant oil

Dispose of chips and used gear lubricant oil according to the regulations.

2.3.2 Electric tools and accessories

Discarded electric tools and accessories contain large quantities of valuable raw and synthetic materials that can be recycled. Therefore:

- Electrical (electronic) devices that are marked with the symbol to the left may not be disposed of with household waste in accordance with EU regulations.
- By actively using the available return and collection systems, you actively contribute to the reuse, recycling and utilization of electrical (electronic) devices.
- Used electrical (electronic) devices contain parts that must be handled selectively according to EU regulations. Separate collection and selective treatment is the basis for environment-friendly disposal and the protection of human health.
- Appliances and products that you bought from us after August 13, 2005 will be disposed of in accordance with legal standards after they have been supplied to us at no cost.
- We may refuse to accept old appliances that pose a risk to human health or safety due to contamination produced during use.
- The end user is responsible for disposing of used appliances introduced to the market before August 13, 2005. Please contact a disposal center near you for this purpose.
- **Important for Germany:** our products may not be disposed of in municipal disposal sites as they are only used for industrial purposes.

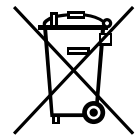

(as per RL 2002/96/EC)

2.3.3 Returning batteries

Some of our units are battery-powered.

- Accumulators and batteries that are marked with one of the symbols to the left may not be disposed of with household garbage according to EU directive 91/157/EEC.
- In batteries containing harmful substances, the chemical sign for the heavy metal contained is indicated below the garbage can: Cd = Cadmium Hg = Mercury Pb = Lead
- **Valid for Germany:** the end user is required to return defective or used batteries to the distributor or to a recycling center established for the purpose.

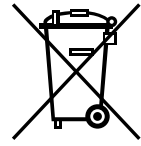

2.4 Basic safety instructions

The machine (hereinafter referred to as the GFX 3.0) is a state-of-the-art machine designed for safe use. The risks involved in using the machine are described in the operating instructions below. Using this machine in a way other than that described in these instructions can lead to serious physical injury and material damage.

Therefore:

- Observe warning messages at all times.
- Keep complete documentation close by the machine.
- Observe country-specific regulations, standards and guidelines.
- Always ensure that the machine is in good working order. Observe the maintenance information (chap. 10, p. 27).
- Only operate the machine if all the safety equipment such as the restart inhibitor, overload protection and chips guard are in good working order and the machine is firmly positioned.
- Report any unusual machine behavior to the person responsible immediately.
- Only use the dimensions and materials specified in these instructions. Other materials should be used only after consulting with Orbitalum Tools customer service.
- Use only original tools, spare parts, materials and accessories from Orbitalum Tools.
- Repair and maintenance work on the electrical equipment may only be carried out by a qualified electrician.
- At the end of each working cycle, before transportation, changing tools, cleaning and performing any maintenance, adjustment or repair work, switch off the machine, allow it to run to a stop and pull the mains plug.
- Do not carry the machine by the cable and do not use the machine to pull out the plug except in an emergency. Protect the cable from heat, oil and sharp edges (chips).
- During operation, keep hands away from the tools.
- Check that the tube is correctly clamped.
- Switch on the machine only when the tube has been clamped.
- In extreme operating conditions conductive dust can settle inside the machine, so to increase safety, the customer should ensure that an SPE-PRCD or FI protect switch is installed by a qualified electrician between the mains supply and the machine.
- When working with the machine, wear safety shoes in accordance with EN ISO 20345 (at least S1), safety goggles in accordance with DIN EN 166, tight-fitting safety gloves in accordance with DIN EN 388 and ear protection in accordance with DIN EN 352.

NOTE The recommendations concerning "Personal protective equipment" only apply to the product being described. Other requirements resulting from the ambient conditions on-site or of other products, or from combining with other products, are not taken into account. These recommendations do not in any way release the responsible body (employer) from its statutory health and safety at work obligations towards its employees.





DANGER

If the mains cable is damaged, live parts may cause death if touched directly!

Fatal electric shock.

- ⊘ Keep the mains cable of the tube saw motor away from the saw blade and/or bevel cutter.
- ⊘ Do not let the cut-off tube piece drop in an uncontrolled manner.
- ⊘ Do not run the machine unattended.
- ▶ During processing, always keep an eye on the position of the mains cable.
- ▶ Secure the falling tube piece.
- ▶ Keep the machine clean. Always remove lubricant residues from the machine.



DANGER

Damaged insulation!

Fatal electric shock.

- ⊘ Do **not** screw any indicators or signs to the drive motor.
- ▶ Use stickers.



DANGER

Metal dust can collect in the motor housing and cause loss of insulation!

Fatal electric shock.

- ▶ Depending on the level of contamination, clean the machine at least once a day using the brush supplied.



DANGER

Damaged plug!

Fatal electric shock.

- ⊘ Do **not** use adapter plugs with ground protected electrical tools.
- ▶ The machine connector plug must fit the socket.



DANGER

Loose/baggy clothing, long hair or jewelry can get caught in rotating machine parts!

Serious injury or death.

- ⊘ During operation, do **not** wear loose/baggy clothing, e.g. neckties.
- ▶ Tie up long hair to prevent it from being caught.



DANGER

Safety components that are contaminated or worn are defective!

The failure of safety components can cause physical injury.

- ⊘ Do **not** misuse the cable, e.g. such as using it to suspend or carry the machine.
- ▶ Replace defective safety components immediately and check them daily to ensure proper operation.
- ▶ Clean and perform maintenance on the machine after each use.
- ▶ Keep cables away from heat, oil, sharp edges and moving equipment parts.
- ▶ Inspect the machine daily for visible signs of damage or defects, and have them repaired by a specialist if necessary.



WARNING

Flying parts/breaking tool!

Diverse physical injuries and material damage.

- ⊘ Do **not** process the tube while it is loose in the vice.
- ⊘ **Never** use a damaged or deformed saw blade and/or bevel cutter.
- ⊘ In the event of tool breakage with a new tool, do **not** enter the old cut because the tool can break again.
- ▶ Clamp the tube to be cut into the vice.
- ▶ Immediately replace worn-out tools.
- ▶ Ensure that the cutting tools are correctly fitted.
- ▶ Tube dimension must be set correctly. During cutting, the saw blade must saw through the entire tube wall.
- ▶ Avoid breaking tool through low (adequate) feed force, correct dimension (see chap. 8.4, p. 22) and speed (see chap. 9.2, p. 25) settings.
- ▶ Hold on to the motor unit tightly by the handle, and guide it with low (adequate) feed force during the machining process.



WARNING

Falling objects or tilting and bending tubes.

Irreversible crushing.

- ▶ Wear safety shoes (in accordance with EN ISO 20345, at least S1).
- ▶ Place sufficient tube supports under the tube.



WARNING

Danger caused by vibration and unergonomic, monotonous work!

Discomfort, tiredness and disruptions to the locomotor system.
Limited ability to react, and cramps.

- ▶ Do relaxation exercises.
- ▶ Ensure activity is varied.
- ▶ Assume an upright and relaxed posture when working.



WARNING

Pressing the ON-OFF switch unintentionally!

Diverse physical injuries and material damage.

- ▶ Before changing tools, cleaning or performing any maintenance, adjustment or repair work, allow the machine to run to a stop and pull the mains plug.



WARNING

Dangerous laser radiation!

The retina of the eyes can be damaged and can thereby impair sight.



- ⊘ Do **not** look at the laser beam or view it using optical instruments.
- ⊘ Do **not** point the laser beam at other people.
- ⊘ Do **not** misuse the line laser and do not remove from the tube saw.

Caution!

Use of controls or adjustments or performance of procedures other than those specified herein may result in hazardous radiation exposure.

2.5 Warning symbols

Observe all of the warnings and safety instructions affixed to the machines.
The following labels also appear on the machine:

Image	Position on machine	Meaning	Code
	Motor	Instruction: Wear safety goggles in accordance with DIN EN 166, ear protection in accordance with DIN EN 352 and tight-fitting safety gloves in accordance with DIN EN 388.	790 086 200
	Motor, frontal	WARNING: Danger of being injured by sharp cutting edges.	790 046 196
	Directly on line laser	WARNING: Laser class I.	For Laser 790 142 125 (230 V machines): 790 142 288 For Laser 790 142 135 (120 V machines): 790 142 298*
	Holder indicut (line laser)	WARNING: Dangerous laser radiation.	790 142 289

* Warning symbol with Code 790 142 298:

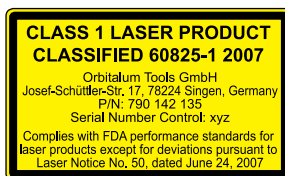

3. PRODUCT DESIGN

3.1 Pipe Cutting and Beveling Machine GFX 3.0

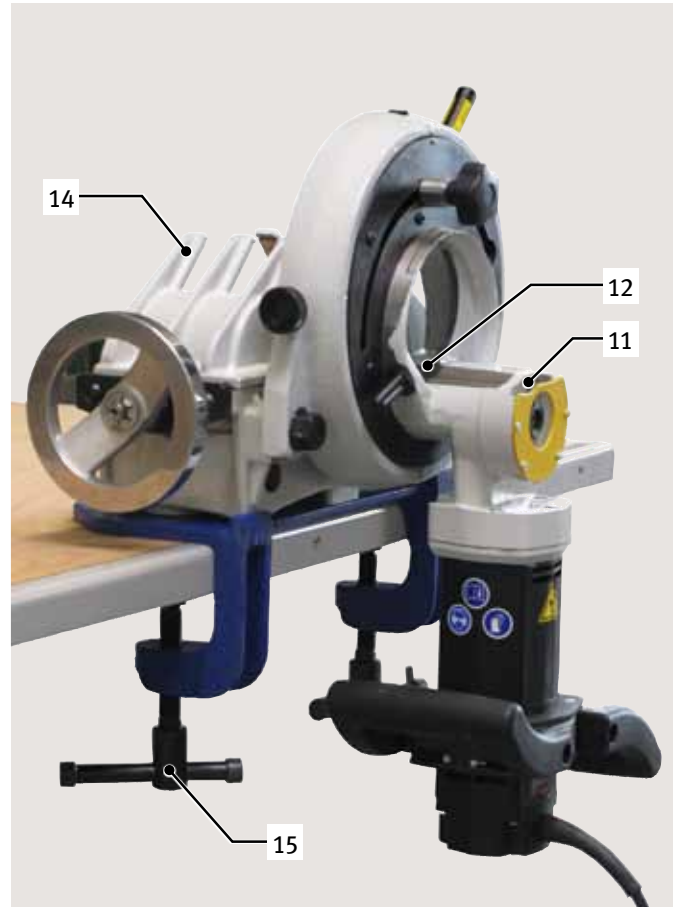
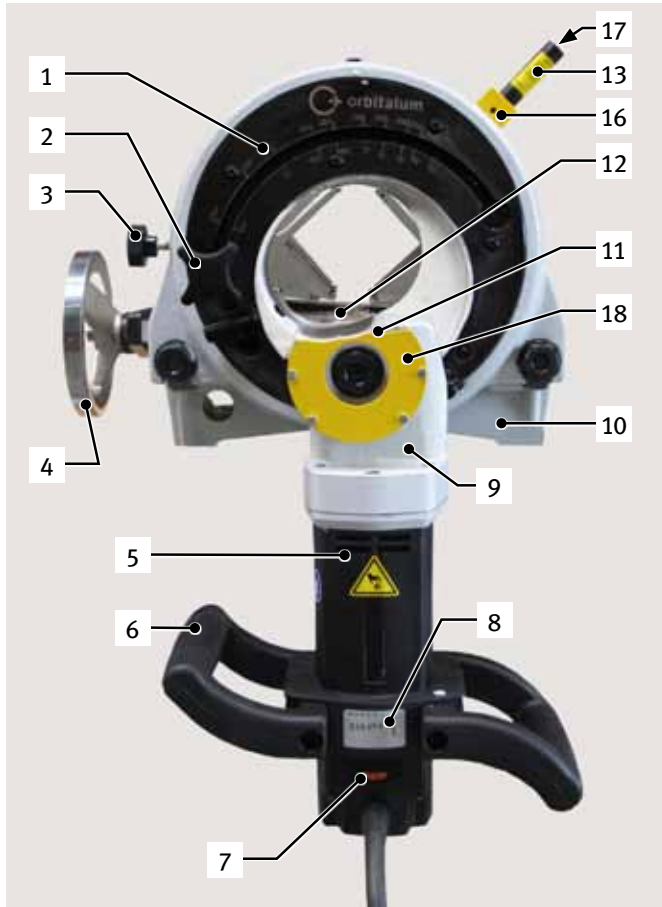

- | | |
|---|--|
| <ul style="list-style-type: none"> 1. Scale for adjusting the tube dimension 2. Star knob for setting the tube dimension 3. Locking screw 4. Hand wheel for clamping jaws 5. Motor (details, see chap. 4.1.1, p. 14) 6. Handle 7. RPM regulator 8. Speed adjustment 9. Slide housing | <ul style="list-style-type: none"> 10. Vice 11. Saw blade clamping point 2 (for cutting tube elbows) 12. Saw blade clamping point 1 13. Line laser (details, see chap. 4.1.3, p. 14) 14. Cast steel clamping jaws 15. Quick-mounting plates with screw clamps
(available as an option, see chap. 3.2.4, p. 13) 16. Holder indicut (line laser) 17. ON-OFF switch line laser 18. Chips guard |
|---|--|

3.2 Accessories

Not included as standard.



WARNING

Danger presented by using poor-quality accessories and tools not approved by Orbitalum Tools!
Diverse physical injuries and material damage.

► Use only original tools, spare parts, materials, and accessories from Orbitalum Tools.

3.2.1 Saw blades and bevel cutters

All saw blades and bevel cutters by Orbitalum Tools are specially developed for our tube and pipe cutters to endure maximum strain and have a maximum tool life. A selection of 4 different saw blades and bevel cutters are available for various uses:



- **Economy Range** for low and non-alloy steels and cast iron pipes
- **Performance Range** for high-alloy steels (stainless steel)
- **High-Performance Range** for high-performance materials and high-alloy steels
- **Premium Range** especially made for stainless steel applications with extra long durability

Workable pipe materials	Al	Mild steel, Cu, CuNi, CuZn, CuSn	INOX, V2A, V4A, 304, 316 (L)	Ti, Duplex, Inconel
Economy	*	*		
Performance		*	*	
High-Performance		*	*	*
Premium			*	

3.2.2 Stainless steel clamping attachment

Ideal for processing stainless steel pipes. Avoids contact corrosion between the pipe and clamping parts. Clamping shells for thin-walled pipes available upon request.

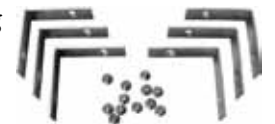

Included:

- 6 stainless steel prismatic plates
- 12 countersunk screws
- 1 socket head key

Article	Code
Complete stainless steel clamping attachment for GFX 3.0	790 144 200

3.2.3 Quick-mounting plate without screw clamps

Complete with bolts and nuts to fit the bench plate to the workbench.

Article	Code
Quick-mounting plate without screw clamps	790 041 026



3.2.4 Quick-mounting plate with screw clamps

To quickly fit machines to workbenches. Ideal if changing location often.

Article	Code
Quick-mounting plate for GFX 3.0, RA 2 (H), RA 21 S	790 041 027



3.2.5 Durable storage and shipping case

High quality padded blue shipping case. Particularly sturdy design.

Article	Code
Durable storage and shipping case	790 144 019



3.2.6 Saw blade lubricant GF TOP

Synthetic high-performance lubricant for cutting and beveling machines. Increases the tool life of the saw blade. Registered according to the NSF H2 food approval. The screwable brush guarantees an easy and uniform application of lubricant on the saw blade.

Article	Code
Saw blade lubricant GF TOP	790 060 228



3.2.7 Saw blade lubricant GF LUB

For cutting and beveling. Increases the tool life of the saw blade. The new ecological lubricant is the environmentally-friendly successor to ROCOL; with a new name and improved quality. GF LUB complies with the latest environmental guidelines and ecological standards. The chlorine-free GF LUB can be ordered using the same article number as the previous lubricant, ROCOL.

Article	Code
Saw blade lubricant GF LUB, Tube, 160 ml	790 041 016



3.2.8 Warning symbols

Overview of warning symbols with order numbers, see chap. 2.5, p. 10.

4. FEATURES AND SCOPE OF APPLICATION

4.1 Features

The GFX 3.0 pipe cutting and beveling machine is distinguished by the following characteristics:

4.1.1 Motor

With built-in variable cutting speed and ergonomic handles.
Enables a safer operating position and cutting of pipe elbows without alteration.

Other advantages:

- Electronic overload protection with integrated temperature monitor and speed control.
- A restart inhibit function prevents the machine from starting in an uncontrolled way after it has been re-connected to the electric mains or after the voltage supply has been re-established following a power failure.
- High performance drive (1200 W) with adjustable speed range for cutting a selection of materials.
- Increased blade life.
- Rotating-speed indicator (3) for speed selection.
- Ergonomically positioned speed adjustment wheel (4) and ON/OFF switch (5).

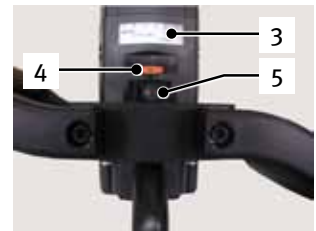

4.1.2 Additional saw blade clamping point for cutting pipe elbows only

Which saw blade clamping point to use?

Saw blade clamping point 1	Saw blade clamping point 2
Cutting pipes	Cutting pipe elbows only



4.1.3 Line laser to determine cut-off point

To determine the cut-off point on the pipe. Ideal for checking whether the pipe is adjusted to the desired cut-off point. A red line marking (1), to determine the cut-off point, appears on the clamped pipe once the red button on the laser pointer has been actuated. If necessary, the pipe position can be corrected until the desired cut-off point is marked.

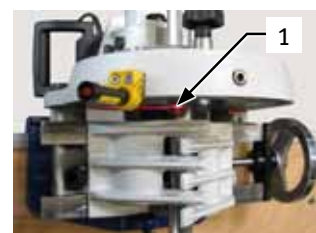

4.1.4 Plug connection with quick-disconnect coupler

For easy and comfortable replacement of the power cable. Also prevents twisting of the cable.

Other advantages:

- If there is a cable fracture, then the cutter motor does not have to be opened and a qualified electrician is not required to replace the flex cable.
- As the flex cable is locked away, misuse can be prevented.



4.1.5 Tempered steel clamping jaws

The GFX 3.0 is fitted with tempered cast steel clamping jaws as standard. A stainless steel clamping attachment is available as an option (see chap. 3.2.2, p. 12). The 6 stainless steel prismatic plates are fitted quickly and easily onto the cast steel clamping jaws to prevent any possible contact corrosion between the pipe and clamping jaw. Clamping shells for thin-walled pipes available upon request.



4.1.6 Other outstanding features

- Enhanced safety due to stationary pipe and rotating tool.
- Self-centering vice.
- Right-angled, burr-free cutting surface and deformation-free pipe cross-section.
- Production of standardized welding bevels.
- Cold machining process.
- Quick cutting process.
- Quick tool change.
- Easy assembly and little space required.
- Simultaneous cutting and beveling of thin-walled metal pipes.
- Working without getting tired when cutting and beveling pipes with larger pipe dimensions and thicker walls.
- Optimized discharge of chips thanks to the design of the vice.
- Environmentally friendly.
- Long service life.
- Lightweight, so easy to handle.
- Increased productivity.
- Low and easy maintenance.

4.2 Scope of application

4.2.1 Application range

Material	Pipe OD (min. - max.)		Saw blade Ø		Wall thickness (min. - max.)	
	[mm]	[inch]	[mm]	[inch]	[mm]	[inch]
Pipes / Pipe elbows	6.0 - 78.0	0.236 - 3.071	63	2.480	0.8 - 5.5	0.032 - 0.217
	6.0 - 73.0	0.236 - 2.874	68	2.677	0.8 - 7.0	0.032 - 0.276
Cylindrical solid material	6.0 - 16.0	0.236 - 0.630	63	2.480	–	–
	6.0 - 21.0	0.236 - 0.827	68	2.677	–	–
Pipe materials	Unalloyed, low-alloy und high-alloy steel, stainless steel, non-ferrous metal, aluminum alloys, titanium alloys, composites and plastic.					

5. TECHNICAL SPECIFICATIONS

5.1 Pipe Cutting and Beveling Machine GFX 3.0

Type of machine	GFX 3.0	
Dimensions	[mm]	570 x 280 x 330
	[inch]	22.44 x 11.02 x 12.99
Weight incl. vice, without clamping shells	[kg]	28.10
	[lbs]	62.04
Power	[W]	1200
Protection class	[class]	II
Built-in electronic variable cutting speed with restart inhibitor	[Rpm]	30 - 200
Versions (1-phase AC)	[V, Hz]	230 V, 50/60 Hz EU
	[V, Hz]	120 V, 50/60 Hz US
Vibration level as per EN 50144	[m/s ²]	< 2.5
Sound pressure level at the workplace ^{*)}	[dB (A)]	79.7

* The noise level was measured under normal operating conditions in accordance with EN 23741.

5.2 Line laser

Dimensions (lxb)	[mm]	68 x 15
	[inch]	2.7 x 0.59
Weight	[g]	30
	[lbs]	0.012
Power, Total Emitted	[mW]	5
	[HP]	5x10 ⁻⁶
Power for Classification	[μW]	< 390
Beam range	[m]	1
	[inch]	3.937
Wave length	[Nm]	650
Operating voltage	[V DC]	2.8 to 4.5
Operating current	[mA]	20
Operating temperature	[°C]	-10 to 40
Storage temperature	[°C]	-40 to 80
Laser class	Class 1	
Battery type	2 x LR44 / AG13	

6. INITIAL OPERATION

6.1 Checking the parts of delivery

- Check delivery for completeness and damage caused by transport.
- Report any missing parts or damage caused by transport to your supplier immediately.

6.2 Included with the machine

Subject to modifications.

- 1 Pipe Cutting and Beveling Machine GFX 3.0
- 1 Transport case
- 1 Saw blade (Code 790 041 035)
- 1 Tool key set
- 1 Tube of saw blade lubricant GF TOP (Code 790 060 228)
- 1 Set of operating instructions and spare parts list

7. STORAGE AND TRANSPORT



ATTENTION

Incorrect machine storage!

Diverse physical injuries and material damage.

- ▶ Store the machine in its original crate in a dry environment.



DANGER

Fatal electric shock!

- ▶ Before transportation or changing the workplace, allow the machine to run to a stop and pull the mains plug.



WARNING

During transportation, the ON/OFF switch may unintentionally be activated causing the machine to start up!

Diverse physical injuries and material damage.

- ▶ Before transportation or changing the workplace, allow the machine to run to a stop and pull the mains plug.



WARNING

Heavy weight when transporting the tube saw!

Danger of being injured through overstraining.

- ▶ Transport tube saws over long stretches with corresponding lifting aids.

7.1 Transporting the machine

For secure transportation, handle the machine as shown below.

1. Clamp an appropriate pipe that is adequately long in the center of the vice.
2. Place the transport straps on both sides around the pipe.
3. Lift the cutter by the straps and mount directly onto the workbench or insert in the assembled quick-mounting plate on the side (fit quick-mounting plate, see chap. 8.1, p. 20).



Position of crate



Removal from crate



Transport

8. SET-UP AND ASSEMBLY



WARNING

When switching the motor on, the tube saw may revolve around the tube automatically!

Diverse physical injuries and material damage.

- ⊘ In their home position, the saw blade and/or bevel cutter must **not** touch the tube.
- ▶ Make sure that the slide housing is in the home position when the cutting process starts.
- ▶ Clamp the tube to be cut into the vice.
- ▶ Before switching the motor on, make sure that the gap between the saw blade and the tube is sufficient, and that the tube is securely clamped in the vice.
- ▶ Place sufficient tube supports under the tube.



WARNING

Flying parts/breaking tool!

Diverse physical injuries and material damage.

- ⊘ Do **not** process the tube while it is loose in the vice.
- ⊘ **Never** use a damaged or deformed saw blade.
- ⊘ In the event of tool breakage with a new tool, do **not** enter the old cut because the tool can break again.
- ▶ Clamp the tube to be cut into the vice.
- ▶ Immediately replace worn-out tools.
- ▶ Ensure that the cutting tools are correctly fitted.
- ▶ Tube dimension must be set correctly. During cutting, the saw blade must saw through the entire tube wall.
- ▶ Avoid breaking tool through low (adequate) feed force, correct dimension (see chap. 8.4, p. 22) and speed (see chap. 9.2, p. 25) settings.
- ▶ Hold on to the motor unit tightly by the handle, and guide it with low (adequate) feed force during the machining process.



WARNING

Flying, hot and sharp-edged chips, tube surfaces, cutting edges and tools!

Danger of injury to eyes and hands.

- ⊘ Do **not** touch the running tool while the machine is in operation.
- ⊘ **Never** work without the saw chip guard mounted.
- ▶ Wear recommended protective clothing.
- ▶ Only remove chips with tight-fitting safety gloves (in accordance with DIN EN 388).
- ▶ Make sure the chips guard is working.

ATTENTION

Damage to material!

- ⊘ When employing an additional cutter, only use the special Orbitalum Tools clamp washer (Code 790 046 188), **not** the normal clamp washer.
- ⊘ **Never** use a damaged or deformed saw blade or cutter.
- ▶ The saw blade and/or bevel cutter must be free from chips and dirt.
- ▶ Only use original Orbitalum Tools saw blades and tools
- ▶ Observe assembly instructions of saw blade guard. The labeling on the saw blade must always face the pipe cutter. The teeth are now arranged in the correct direction.

8.1 Fitting the GFX 3.0 onto the workbench

- Read and observe the warning messages in chap. 8, p. 19.

Fit the pipe cutter to the workbench; either:

- directly onto the workbench, or
- onto the quick-mounting plate without screw clamps, or
- onto the quick-mounting plate with screw clamps.

8.1.1 Mounting the machine without quick-mounting plate directly onto the workbench

1. Mark and punch the bolt holes on the workbench. Use the GFX 3.0 as a template.
2. Drill \varnothing 13 mm holes.
3. Fit the GFX 3.0 with the provided countersunk onto the workbench.

8.1.2 Mounting the machine with quick-mounting plate without screw clamps

1. Fit the quick-mounting plate with the screw clamps onto the workbench.
2. Guide the pipe cutter sideways onto the fitted quick-mounting plate. Tighten the hexagonal bolt (1).

8.1.3 Mounting the machine with quick-mounting plate without screw clamps

1. Mark and punch the bolt holes on the workbench. Use the quick-mounting plate as a template.
2. Drill \varnothing 13 mm holes.
3. Fasten the quick-mounting plate with screws.
4. Guide the pipe cutter sideways onto the fitted quick-mounting plate. Tighten the hexagonal bolt (1).

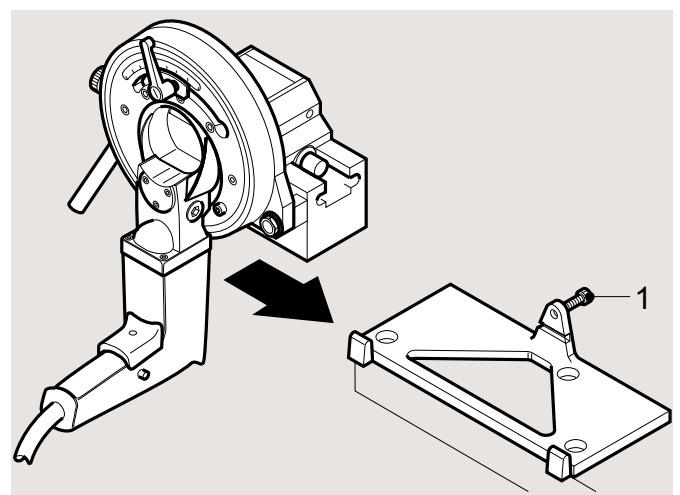
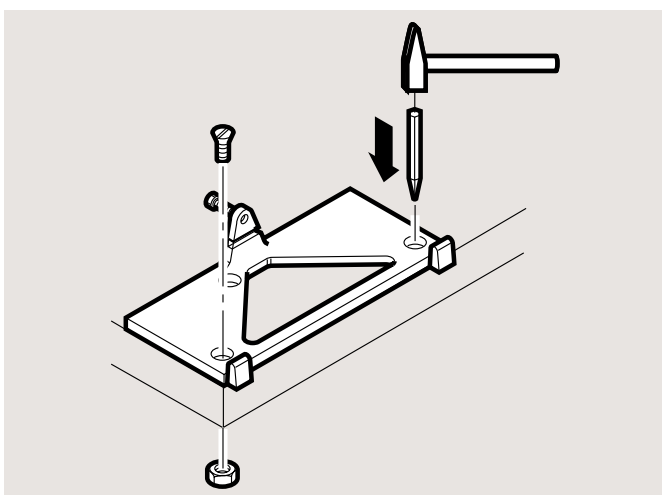

8.2 Saw blade clamping point 1: Fitting the saw blade/bevel cutter

- Read and observe the warning messages in chap. 8, p. 19.

Only use saw blade clamping point 1 **to cut and bevel pipes**. If you want to cutting pipe elbows, use saw blade clamping point 2 (see chap. 8.3, p. 22).

NOTE Saw blades/bevel cutters can only be fitted or replaced if **no pipe is clamped in the vice**. If necessary, remove the pipe before fitting the saw blade

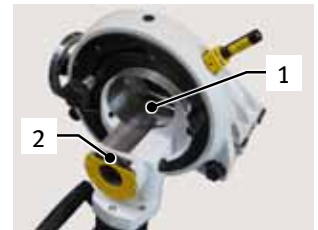

8.2.1 Inserting the saw blade

1. Turn the pipe cutter clockwise and upwards by 180°.
2. Tighten the locking screw (2).
3. Clean the saw blade shaft (1) and vicinity with a brush.
4. Place onto the shaft (1):
Saw blade (3) and clamping plate (4).
5. Tighten nut (5) counterclockwise (left-hand thread).
6. Loosen the locking screw (2).
7. Turn the pipe cutter clockwise and downwards to its home position.

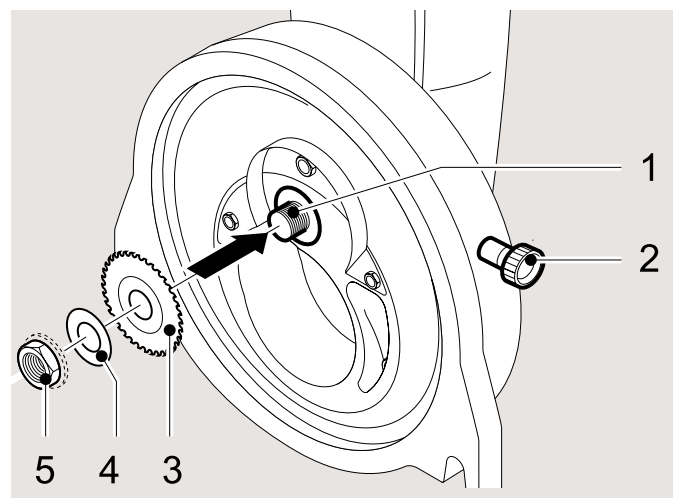

8.2.2 Inserting the saw blade/bevel cutter combination or a bevel cutter

1. Turn the pipe cutter clockwise and upwards by 180°.
2. Tighten the locking screw (2).
3. Clean the saw blade shaft (1) and vicinity with a brush.
4. Place onto the shaft (1):
Saw blade (3) and bevel cutter (4).
5. Tighten nut (5) counterclockwise (left-hand thread).
6. Loosen the locking screw (2).
7. Turn the pipe cutter clockwise and downwards to its home position.

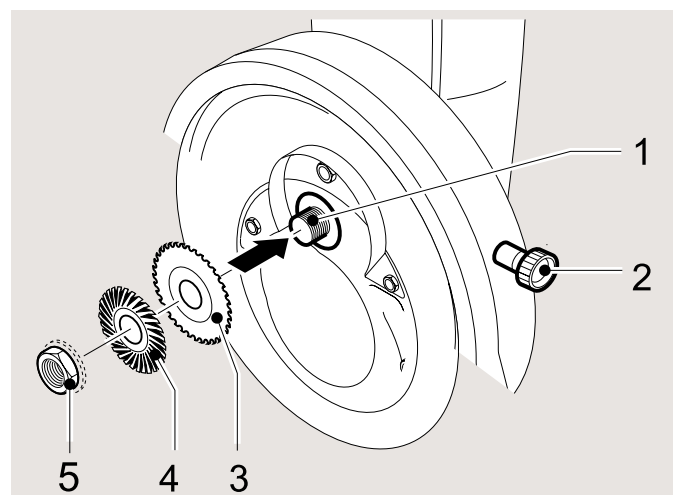

8.3 Saw blade clamping point 2: Fitting the saw blade

- ▶ Read and observe the warning messages in chap. 8, p. 19.

Only use saw blade clamping point 2 **to cutting pipe elbows**. If you want to cut or bevel pipes, use saw blade clamping point 1 (see chap. 8.2, p. 21).

NOTE Saw blades can only be fitted or replaced if **no** pipe is clamped in the vice. If necessary, remove the pipe before fitting the saw blade.

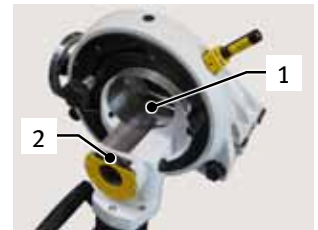

8.3.1 Inserting the saw blade

1. Clean the saw blade shaft (1) and vicinity.
2. Place onto the shaft (1): Saw blade (3) and clamping plate (4).
3. Tighten nut (5) clockwise.

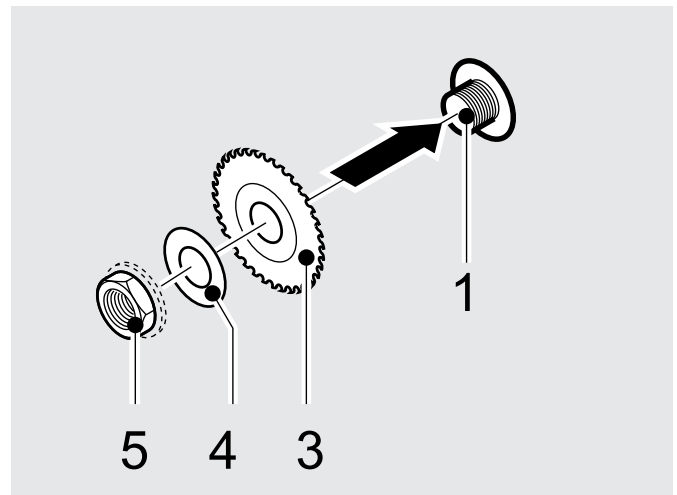
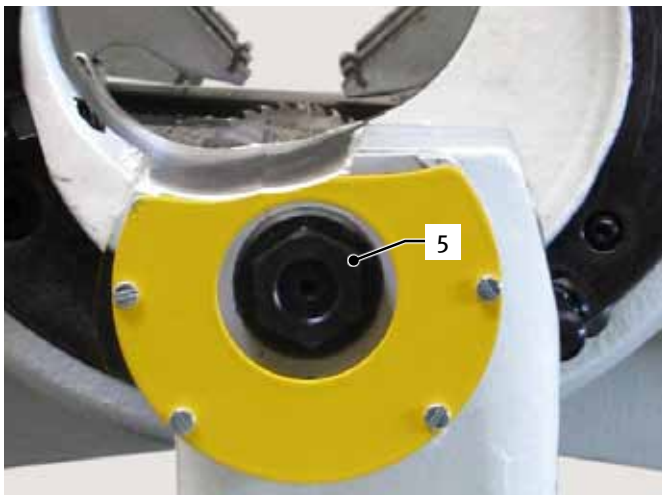

8.4 Adjusting the pipe dimension

- ▶ Read and observe the warning messages in chap. 8, p. 19.

NOTE ▶ The steps for adjusting the pipe dimension are identical for both saw blade clamping points.

8.4.1 Setting the pipe dimension with a scale

1. Loosen the star knob (1).
2. Select the pipe dimension on the scale (2).
3. Slide the star knob (1) in the direction of the arrow to the desired pipe dimension.
4. Tighten the star knob (1).

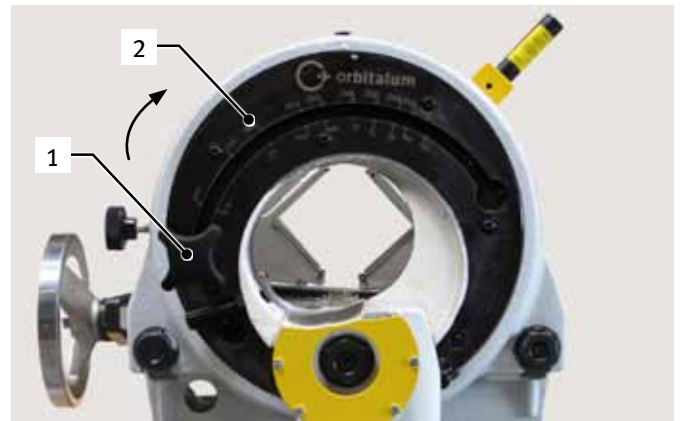

8.4.2 Setting the pipe dimension without a scale

1. Place the pipe in the vice.
2. Slide the pipe forwards until it is close to the saw blade.
3. Clamp the pipe in the vice.
4. Loosen the star knob (1) and set to "2 1/2 inch". Do not tighten.
5. Raise the motor of the pipe cutter in the direction of the arrow as if to saw until the teeth of the saw blade protrude approx. 1.5 mm/0.059 inch (approx. height of saw blade teeth) into the center of the pipe.
6. Tighten the star knob (1).

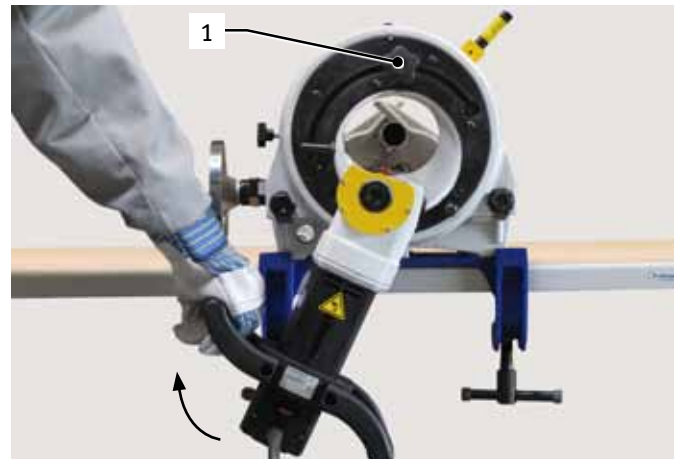

8.4.3 Setting the pipe dimension when using an additional cutter

Steel pipes with a wall thickness of 7 mm (0.276 inch) can be simultaneously cut and beveled.

1. Place the pipe in the vice.
2. Slide the pipe forwards until it is close to the additional cutter.
3. Clamp the pipe in the vice.
4. Loosen the star knob (1) and set to 2 1/2 inch. Do not tighten.
5. Raise the motor of the pipe cutter until the bevel cutter covers the pipe wall.
6. Tighten the star knob (1).
7. Perform a test bevel and check the bevel (see chap. 9, p. 24).

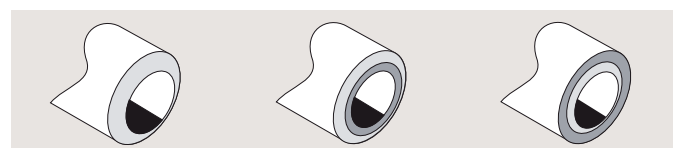
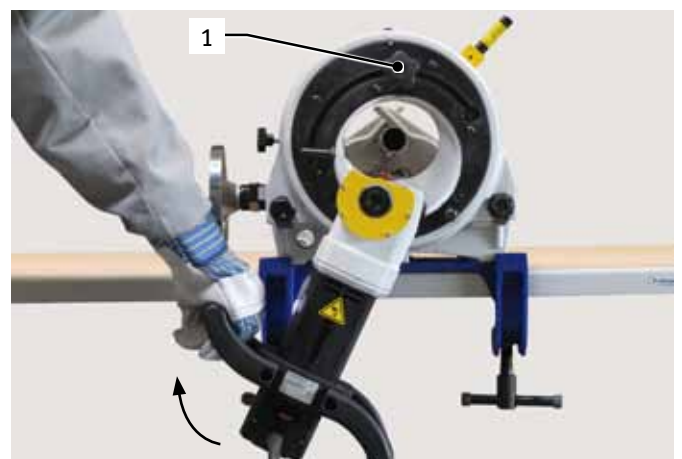

Bevel OK

Move the star knob (1) slightly to the right

Move the star knob (1) slightly to the left

9. OPERATION



DANGER

Machine start-up due to unintentional pressing of the ON/OFF switch or the speed regulator.

Fatal electric shock!

Diverse physical injuries and material damage!

- ▶ Prior to assembly, dismantling, maintenance and adjustment work, disconnect the machine
- ▶ from the mains supply and allow it to run to a stop.



DANGER

When the slide housing is rotating, excess lubricant can get into the motor unit.

Fatal electric shock!

- ▶ Remove excess lubricant from the machine after every step.



WARNING

Flying parts/breaking tool!

Diverse physical injuries and material damage.

- ⊘ Do **not** process the tube while it is loose in the vice.
- ⊘ **Never** use a damaged or deformed saw blade.
- ⊘ In the event of tool breakage with a new tool, do **not** enter the old cut because the tool can break again.
- ▶ Clamp the tube to be cut into the vice.
- ▶ Immediately replace worn-out tools.
- ▶ Ensure that the cutting tools are correctly fitted.
- ▶ Tube dimension must be set correctly. During cutting, the saw blade must saw through the entire tube wall.
- ▶ Avoid breaking tool through low (adequate) feed force, correct dimension (see chap. 8.4, p. 22) and speed (see chap. 9.2, p. 25) settings.
- ▶ Hold on to the motor unit tightly by the handle, and guide it with low (adequate) feed force during the machining process.



WARNING

Risk of machine and tube falling!

Irreversible crushing.

- ▶ Check the machine's position and secure it so it cannot fall.
- ▶ Support tubes using tube stands.



WARNING

Trapped fingers between the vice/clamping shell and tube!

Irreversible crushing.

- ⊘ Do **not** insert fingers between the vice/clamping shell and tube.



ATTENTION

Restarting the machine following blockage!

Diverse physical injuries and material damage.

- ▶ In the event of a blockage, always disconnect the machine from the power supply before clearing it.
- ▶ If necessary, remove any tensioned parts before restarting the machine.



ATTENTION

Vapors when working with lubricants!

Damage to lungs, skin and the environment.

- ▶ Only use original lubricant recommended by Orbitalum Tools.



DANGER

Unexpected start-up!!

Serious injury or death.

- ▶ Before connecting the machine to the power supply, check the on/off switch is switched off.



DANGER

Loose/baggy clothing, long hair or jewelry can get caught in rotating machine parts!

Serious injury or death.

- ⊘ During operation, do **not** wear loose/baggy clothing, e.g. neckties.
- ▶ Tie up long hair to prevent it from being caught.



WARNING

Body parts can fit between the cutting tools and the tube!

Serious injury.

- ⊘ Do **not** place body parts between the cutting tools and the tube.



WARNING

Flying, hot and sharp-edged chips, tube surfaces, cutting edges and tools!

Danger of injury to eyes and hands.

- ⊘ Do **not** touch the running tool while the machine is in operation.
- ⊘ **Never** work without the saw chip guard mounted.
- ▶ Wear recommended protective clothing.
- ▶ Only remove chips with tight-fitting safety gloves (in accordance with DIN EN 388).
- ▶ Make sure the chips guard is working.

9.1 Shutting down (even in an emergency)



WARNING

Pulling the plug does not perform the EMERGENCY STOP function!

Diverse physical injuries and material damage.

- ⊘ Do **not** use crimped cables.
- ▶ Ensure the plug is not obstructed.
- ▶ Simulate an emergency by carrying out a practice plug removal.

To be able to stop the machine (also in case of emergency), perform the corresponding steps and immediately remove from the danger area, until the machine comes to a stop:

- ▶ Activate by switching the ON/OFF toggle switch (1).

If the ON/OFF toggle switch (1) fails to work:

- ▶ Remove the plug from the socket or vacate the danger zone as quickly as possible.



9.2 Selecting the speed levels

Pipe material	Controller setting	Spindle speed (rpm)
High-alloy/high-quality steels	1 - 3	30 - 98
Low-alloy/high-quality steels	3 - 5	98 - 166
Construction steel	5 - 6	166 - 200



IMPORTANT Select a low speed for large pipe diameters and wall thicknesses.

9.3 Cutting pipes

1. Fit saw blade and/or bevel cutter (saw blade clamping point 1, see chap. 8.2, p. 21; saw blade clamping point 2 to cutting pipe elbows, see chap. 8.3, p. 22).
2. Adjust the bevel cutter to the pipe dimension (see chap. 8.4, p. 22).
3. Connect pipe cutter to power supply.

IMPORTANT Apply saw blade lubricant to teeth of saw blade. Repeat lubrication **every 3 cuts**. Only use saw blade lubricant/paste (no oils) from Orbitalum Tools (e.g. GF LUB or GF TOP). Keep the machine clean. Always remove lubricant residues from the machine.

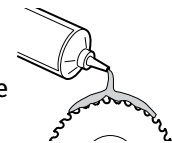

4. Place the pipe in the vice (2).
5. Slide pipe to the desired cut-off point; mark the cut-off point on the pipe using the line laser (1).
6. Clamp the pipe in the vice using the hand wheel (3).

7. Switch the saw motor on at the ON/OFF switch (4).
8. Set the desired speed level using the speed regulator (5) (for standard values, see chap. 9.2, p. 25).
9. Carefully turn the pipe cutter in a clockwise direction until the pipe wall has been pierced through.
10. Continue turning rapidly until the pipe has been cut off and the marks (6) are aligned on the slide housing and body.
11. Turn the pipe cutter back to its home position.
12. Switch the saw motor off again at the ON/OFF switch (4).

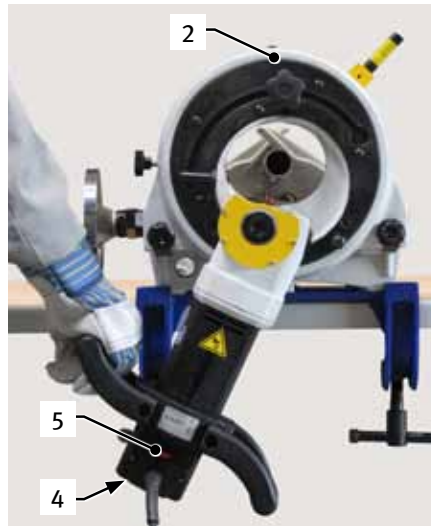
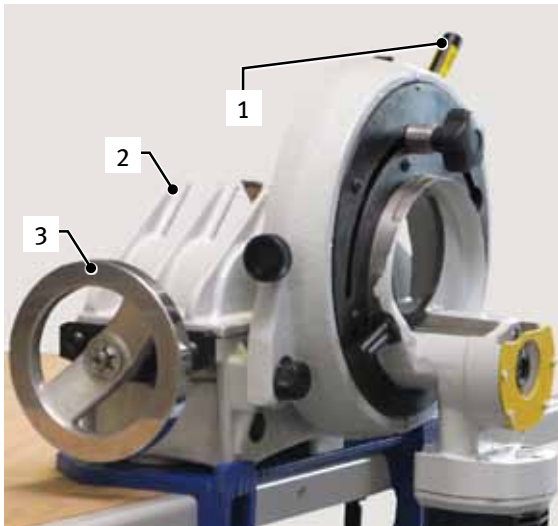

NOTE For continuous operation:
At the end of shifts or during long breaks, loosen the blade clamping nut to reduce the pressure on oil seals etc.. Ensure that the nut is retightened before cutting commences.

9.4 Beveling pipes

The necessary work steps for beveling pipes are identical to chap. 9.3, p. 25.

9.5 Cutting and beveling pipe simultaneously

The necessary work steps for simultaneously cutting and beveling are identical to chap. 9.3, p. 25.
The pipe cutter however must revolve much slower around the pipe than when cutting, since two tools are being used at the same time.

9.6 Cutting pipe elbows

- ▶ Pipe elbows are cut at saw blade clamping point 2 (Saw blade assembly, see chap. 8.3, p. 22). The necessary work steps for cutting pipe elbows are identical to chap. 9.3, p. 25.



10. SERVICING, MAINTENANCE, TROUBLESHOOTING

NOTE Some of the work mentioned depends a great deal on the use and on the ambient conditions. The cycles specified are minimum specifications. In individual cases, differing maintenance cycles are possible. To ensure the safety of the machine, perform maintenance annually using an authorized service center with VDE testing. If the machine does not function as previously described, the machine must also be sent into an authorized service center.

 **DANGER** **Danger of death by electric shock!**
 Non-observance could result in death or serious injury.
 ► Before the maintenance work is carried out, allow the machine to run to a stop and pull the mains plug.

 **DANGER** **Risk of electric shock due to poor electrics!**
 Fatal electric shock.
 ► Before the maintenance work is carried out, allow the machine to run to a stop and pull the mains plug.
 ► Repair and maintenance work on the electrical equipment may only be carried out by a qualified electrician.

10.1 Maintenance

Time/Interval	Activity
Weekly	<ul style="list-style-type: none"> ► Remove the saw blade and use the brush to remove any saw chips. ► Lubricate the 4 points indicated by the arrows.

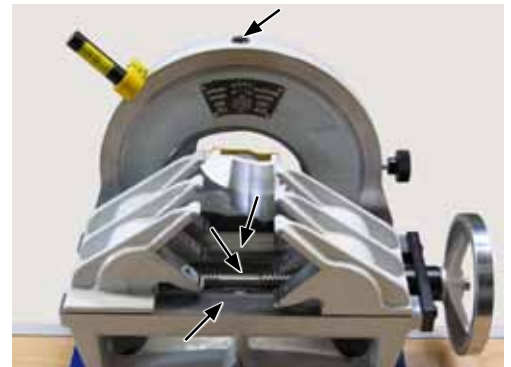

When cleaning and when changing tools	<ul style="list-style-type: none"> ⊘ Do not use compressed air to clean the area at the end of the shaft (marked with an arrow) as the rotary shaft seal may otherwise be damaged by chips. ► Use a cloth or brush to clean the end of the shaft.
---------------------------------------	--

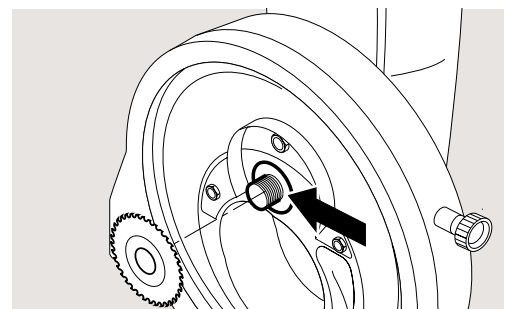

10.1.1 Laser

- No maintenance for the laser required.
- For the Laser is no service allowed.
- The laser has to be returned to the factory for any service or repair.
- It is not allowed to open, modify or to remove protective covers or housings except for battery change.

10.2 Mounting instruction for laser/Change of batteries

It is not allowed to open, modify or to remove protective covers or housings except for battery change.

1. Loosen the threaded pin M4x4 (1) (Code 445 001 003) by using allen key SW2 to remove the laser from the cover plate.
2. Exchange the batteries.
3. After putting the laser in the holder the laser has to be adjusted and the threaded pin M4x4 (Code 445 001 003) has to be tightened with allen key SW2.

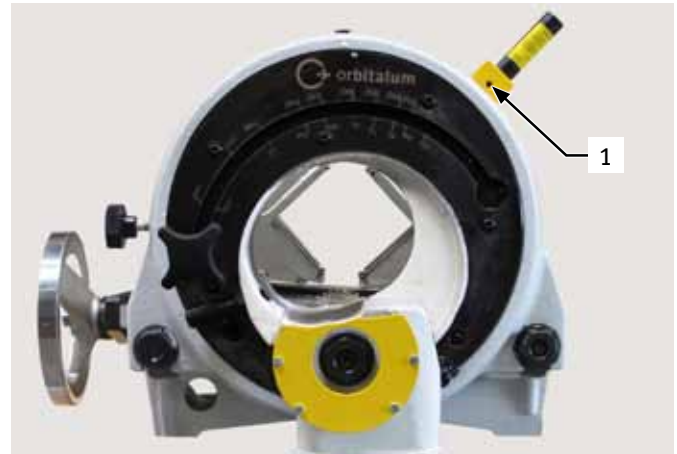

10.3 What to do if ...? – General trouble shooting

Problem	Possible cause	Remedy
The pipe cutter will not turn.	The locking screw is tight.	▶ Loosen the locking screw.
	Incorrect pipe dimension.	▶ Set the pipe dimension correctly.
The saw blade is not cutting and is slipping through.	The nut on the saw blade shaft is not tight enough.	▶ Tighten the nut.
The saw blade is not cutting.	The saw blade has been inserted the wrong way round.	▶ Insert the saw blade so that the labeling on the saw blade faces the pipe cutter.
The pipe is not cut concentrically.	The pipe cutter has been incorrectly flanged. The flange surfaces are contaminated.	▶ Remove the pipe cutter, clean the fixing parts and flange surfaces, re-flange the saw.
The pipe is not cut.	Pipe dimension not correctly set.	▶ Adjust the bevel cutter to the pipe dimension (see chap. 8.4, p. 22).
	The clamping lever is not tightened.	▶ Tighten the clamping lever.
The motor does not start.	The auto startup inhibitor is active because the On switch is locked.	▶ Release the locking button and press the On switch again.

10.4 Servicing/customer service

For ordering spare parts, refer to the separate spare parts list.
For troubleshooting, please contact the branch responsible directly.

Please indicate the following details:

- Type of machine: Pipe Cutting and Beveling Machine **GFX 3.0**
- Machine-no.: (see type plate)

11. EG DECLARATION OF CONFORMITY



EG-Konformitätserklärung
Declaration of conformity
Dichiarazione di conformità
Déclaration de conformité
Declaración de conformidad

Orbitalum Tools GmbH
Josef-Schüttler-Straße 17
78224 Singen, Deutschland
Tel.: +49 (0) 77 31 792-0
Fax: +49 (0) 77 31 792-524

According to machine guideline 2006/42/EG (MaschR) and the EMC Directive 2004/108/EC.

Die Bauart der Maschine:
The following product:
Il seguente prodotto:
Le produit suivant:
El producto siguiente:

GFX 3.0 Pipe Cutting and Beveling Machine*

Seriennummer:
Series number:
Numero di serie:
Nombre de série:
Número de serie:

Baujahr / Year / Anno / Année / Año:

ist entwickelt, konstruiert und gefertigt in Übereinstimmung mit folgenden EG-Richtlinien:
was designed, constructed and manufactured in accordance with the following EC guidelines:
è stata progettato costruito e commercializzato in osservanza delle seguenti Direttive:
a été dessiné, produit et commercialisé selon les Directives suivantes:
ha sido proyectado construido y comercializado bajo observación de las siguientes Directivas:

Maschinen-Richtlinie (2006/42/EG)
EMV-Richtlinie (2004/108/EG)
Niederspannungsrichtlinie (2006/95/EG)
2000/14/EG

Folgende harmonisierte Normen sind angewandt:
The following harmonized norms have been applied:
Le seguenti norme armonizzate ove applicabili:
Les normes suivantes harmonisées où applicables:
Las siguientes normas armonizadas han sido aplicadas:

DIN EN ISO 13849-1 (2008)
DIN EN ISO 13849-2 (2008)
DIN EN ISO 12100-1 (2010)
DIN EN ISO 12100-2 (2010)
DIN EN ISO 14121-1 (2007)
DIN EN 1037 (2008)
DIN EN 60745 (2010)
DIN EN 61029-1 (2010)
DIN EN 60204-1 (2009)

* including all accessories of Orbitalum Tools.

Authorised to compile the technical file is Mr. Gerd Riegraf, Orbitalum Tools GmbH, D-78224 Singen.

Singen, 22.01.2010

Markus Tamm
Managing Director

Hasan Caglar
Business Unit Manager Cutting + Beveling

**We value
your opinion!**

Please send us
your comments
and queries.



Orbitalum Tools GmbH
Josef-Schuettler-Str. 17
78224 Singen, Germany
Tel. +49 (0) 77 31 792-0
Fax +49 (0) 77 31 792-524
tools@orbitalum.com
www.orbitalum.com

790 144 762_00 | EN | 12.11
© Orbitalum Tools GmbH
78224 Singen
Printed in Germany